



BD20032 - Lincat Blu Refrigerated Chef Base - W 838 mm - 600 W

In busy kitchens where speed is crucial, caterers need quick and easy access to food at the point of cooking, Blu° refrigerated chef bases provides the ideal solution.

- ✓ Designed to accommodate heavy equipment, including Opus 800 Series chargrills, griddles and hobs
- ✓ Drawers hold 1/1 GN 100mm deep containers
- ✓ Allows bulk storage and easy access to food at point of cooking
- ✓ Ideal for meat and fish
- ✓ Adjustable thermostat -2° to +8°C
- ✓ Self closing heavy duty drawers
- ✓ Supplied on castors as standard

Specifications

Summary

Brand	Lincat
Range	Blu
Power Type	Electric
Unit Type	Free-standing
Available in UK Only	No
UK Warranty	2 Years Parts and Labour Warranty
Export Warranty	Contact your local dealer
GTIN	5056105117919

Power and Performance

Total Power kW	0.6
Temperature Range °C	-2 to +8
Temperature Control	Electronic
Cooling Capacity Watts	600
Energy Grade	D
Annual Energy Consumption kWh/Annum	982
Climate Class	5

Key Specifications

Refrigerant Type	R452a
Construction/Finish	304 Grade S/S Ext/Int
Number of Drawers	2
Base Mounting	Castors
Insulation Material/Thickness	Cyclopentane [60mm]
Maximum Ambient Temperature °C	40
Auto Defrost	Yes
HACCP Compliant	Yes

Capacity

Gastronorm Capacity	2 x GN 1/1
----------------------------	------------

Weights and Dimensions

Unit Height (External) mm	615
Unit Width (External) mm	838
Unit Depth (External) mm	826
Net Weight Kg	125

Supply Connections

Requires Installation	No
Requires Electrical Supply	Yes
UK 3 Pin Plug	Yes
Requires Hardwiring	No
Electrical Supply Rating Watts	600
Single Phase Amps	1.5
Single Phase Voltage	230

Shipping

Packed Weight Kg	137.5
Packed Height cm	75
Packed Width cm	97
Packed Depth cm	97

Technical Picture

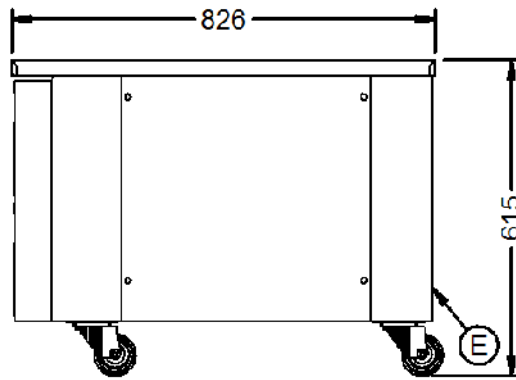
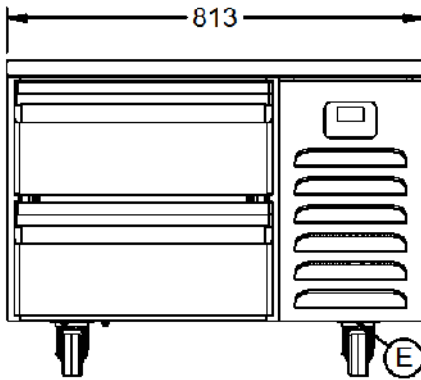
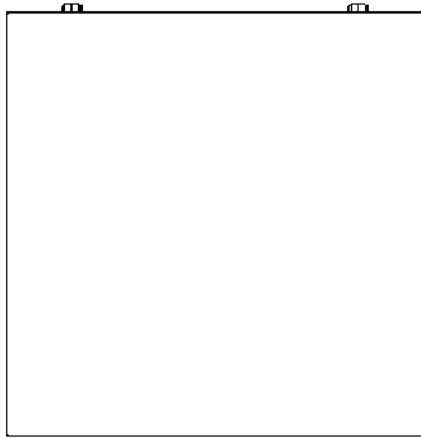

Lincat Limited

Whisby Road,
Lincoln, LN6 3QZ,
United Kingdom

Company No: 2175448

A member company of



Customer Care

Tel: +44 1522 875500
Email: care@lincat.co.uk

Export Customers

Tel: +44 1522 875536
Email: export@lincat.co.uk

Opening Hours

Monday – Friday:
8.30am – 5pm