



BM6C - Lincat Silverlink 600 Electric Counter-top Bain Marie - Dry Heat - Gastronorms - Base + Dish Pack - W 600 mm - 0.75 kW

The Silverlink 600 Electric Dry Heat Bain Marie safely holds sauces, soups, gravy and precooked foods for up to two hours at the ideal serving temperature

- ✓ Dry heat bain marie
- ✓ Ideal for holding foods for up to 2 hours at serving temperature
- ✓ 6 x 1/4 150mm deep gastronorms with lids are included
- ✓ Plug and play for an easy installation
- ✓ Perfect for safely holding sauces, gravy & pre-cooked foods
- ✓ Adjustable temperature control

Specifications

Summary		Power and Performance	
Brand	Lincat	Total Power kW	0.75
Range	Silverlink 600	IP Rating	IP33
Power Type	Electric	Temperature Control	Mechanical
Unit Type	Counter-top		
Available in UK Only	No		
UK Warranty	2 Years Parts and Labour Warranty		
Export Warranty	Contact your local dealer		
GTIN	5056105100492		

Key Specifications		Capacity	
Pot Type	Gastronorm	Gastronorm Capacity	6 x GN1/4
Type of Heat	Dry		

Weights and Dimensions		Supply Connections	
Unit Height (External) mm	290	Requires Installation	No
Unit Width (External) mm	600	Requires Electrical Supply	Yes
Unit Depth (External) mm	600	UK 3 Pin Plug	Yes
Net Weight Kg	17.1	Requires Hardwiring	No
		Electrical Supply Rating Watts	750
		Single Phase Amps	3.3
		Single Phase Voltage	230

Shipping	
Packed Weight Kg	18.81
Packed Height cm	49.5
Packed Width cm	70
Packed Depth cm	70

Available Accessories

CC6	Lincat Silverlink 600 Free-standing Ambient Open-Top Pedestal with Doors - W 600 mm
CN6	Lincat Silverlink 600 Free-standing Ambient Open-Top Pedestal without Doors - W 600 mm
HC6	Lincat Silverlink 600 Free-standing Heated Open-Top Pedestal with Doors - W 600 mm - 0.5 kW
HCL6	Lincat Silverlink 600 Free-standing Heated Pedestal with Legs and Doors - W 600 mm - 0.5 kW

Available Accessories

SLS6

Lincat Silverlink 600 Free-standing Floor Stand - for units W 600 mm

Technical Picture

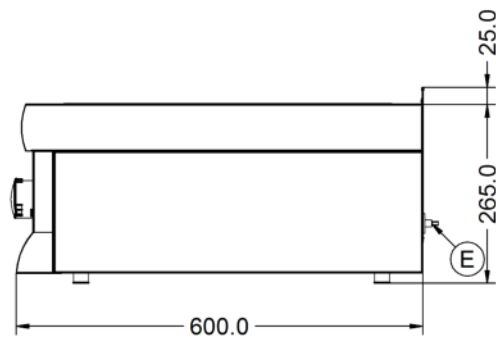
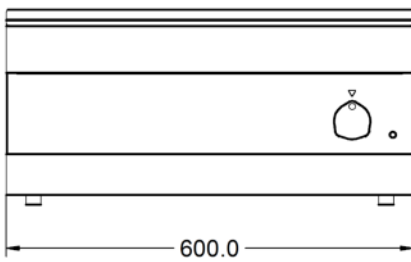
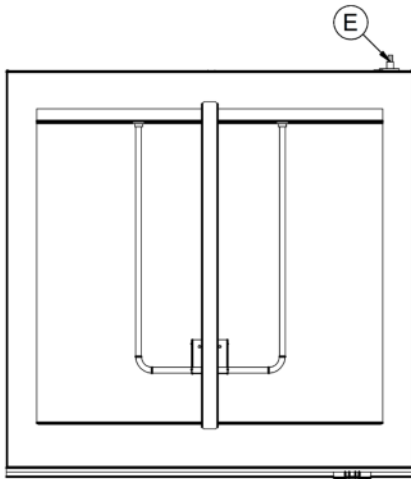



Lincat Limited

Whisby Road,
Lincoln, LN6 3QZ,
United Kingdom

Company No: 2175448

A member company of



Customer Care

Tel: +44 1522 875500
Email: care@lincat.co.uk

Export Customers

Tel: +44 1522 875536
Email: export@lincat.co.uk

Opening Hours

Monday – Friday:
8.30am – 5pm