



DOMINA PRO 700 - NEUTRAL ELEMENTS

N77T



TOP

**TECHNICAL DATA:**

|                                  |                          |
|----------------------------------|--------------------------|
| External dimensions - WxDxH (cm) | 70x73x25                 |
| Drawer                           | <input type="checkbox"/> |

**ADDITIONAL TECHNICAL DATA:**

|             |     |
|-------------|-----|
| Weight (kg) | 25  |
| Volume (m3) | 0,3 |

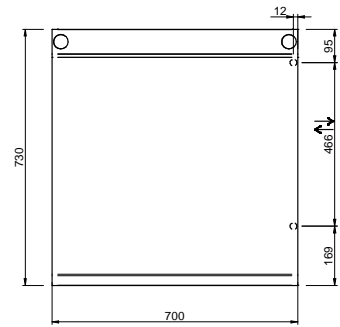
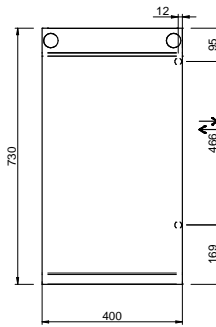
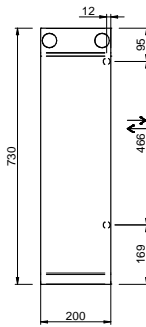
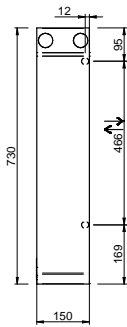
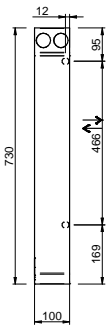
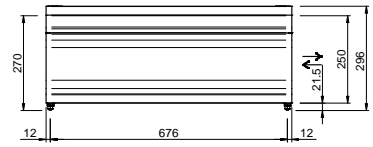
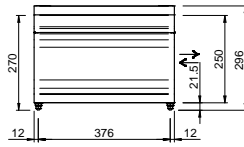
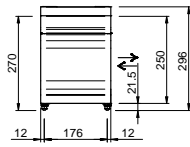
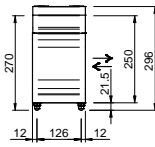
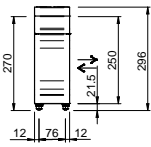

LEGENDA SIMBOLI / LEGEND



INGRESSO GAS / GAS INLET  
(EN 10226-1) Ø M 1/2"



ALIMENTAZIONE ELETTRICA /  
POWER SUPPLY



INGRESSO ACQUA /  
WATER INLET Ø M 1/2"



SCARICO ACQUA / OLII  
WATER / OILS DRAIN



ATTACCO EQUIPOTENZIALE /  
EQUIPOTENTIAL



REGOLAZIONE PIEDINI /  
FEET ADJUSTMENT (h 0/+50)  
/ TOP VERSION (h 0/+5)