



DOMINA PRO 900 - BOILING PANS

PEG98A150



DIRECT HEATING, GAS MONOBLOC

TECHNICAL DATA:

External dimensions - WxDxH (cm)	80x90x85
Boiling pan capacity (lt)	150
Total power (kW)	21
IPX5	●

ADDITIONAL TECHNICAL DATA:

Boiling pan dimensions - ØxH (cm)	60x54
Weight (kg)	123
Volume (m3)	1,1

The tank sides and the interspace are in AISI 304, the bottom is in AISI 316 for greater resistance to corrosion. The AISI 304 lid ensures minimal loss of steam and heat (double insulation lid is available as option to guarantee better thermal insulation). Hot and cold water tap with swivel nozzle is placed on top of the worktop. Indirect heating generated by the low pressure steam of the interspace water evenly heats the surface of the container. Interspace water-level viewer in the front panel.

Gas versions: stainless steel tubular burner with self-stabilizing flame. Pilot flame with thermocouple safety device. Piezo-electric ignition of the pilot. Safety valve with pressure gauge.

Electric versions: power adjustment with 4-position switch, pressure gauge for the automatic control of the interspace steam, safety valve with gauge.

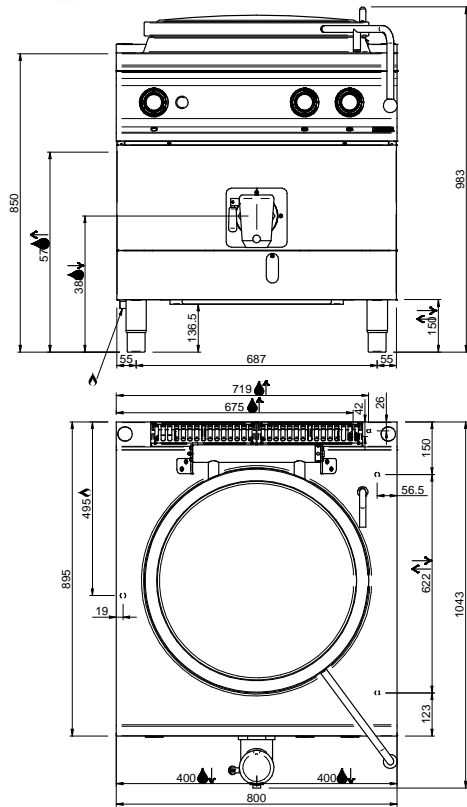

LEGENDA SIMBOLI / LEGEND



INGRESSO GAS / GAS INLET
(EN 10226-1) Ø M 1/2"



ALIMENTAZIONE ELETTRICA /
POWER SUPPLY



INGRESSO ACQUA /
WATER INLET Ø M 1/2"



SCARICO ACQUA / OLII
WATER / OILS DRAIN



ATTACCO EQUIPOTENZIALE /
EQUIPOTENTIAL



REGOLAZIONE PIEDINI /
FEET ADJUSTMENT (h 0/+50)
/ TOP VERSION (h 0/+5)