

Product Dimensions

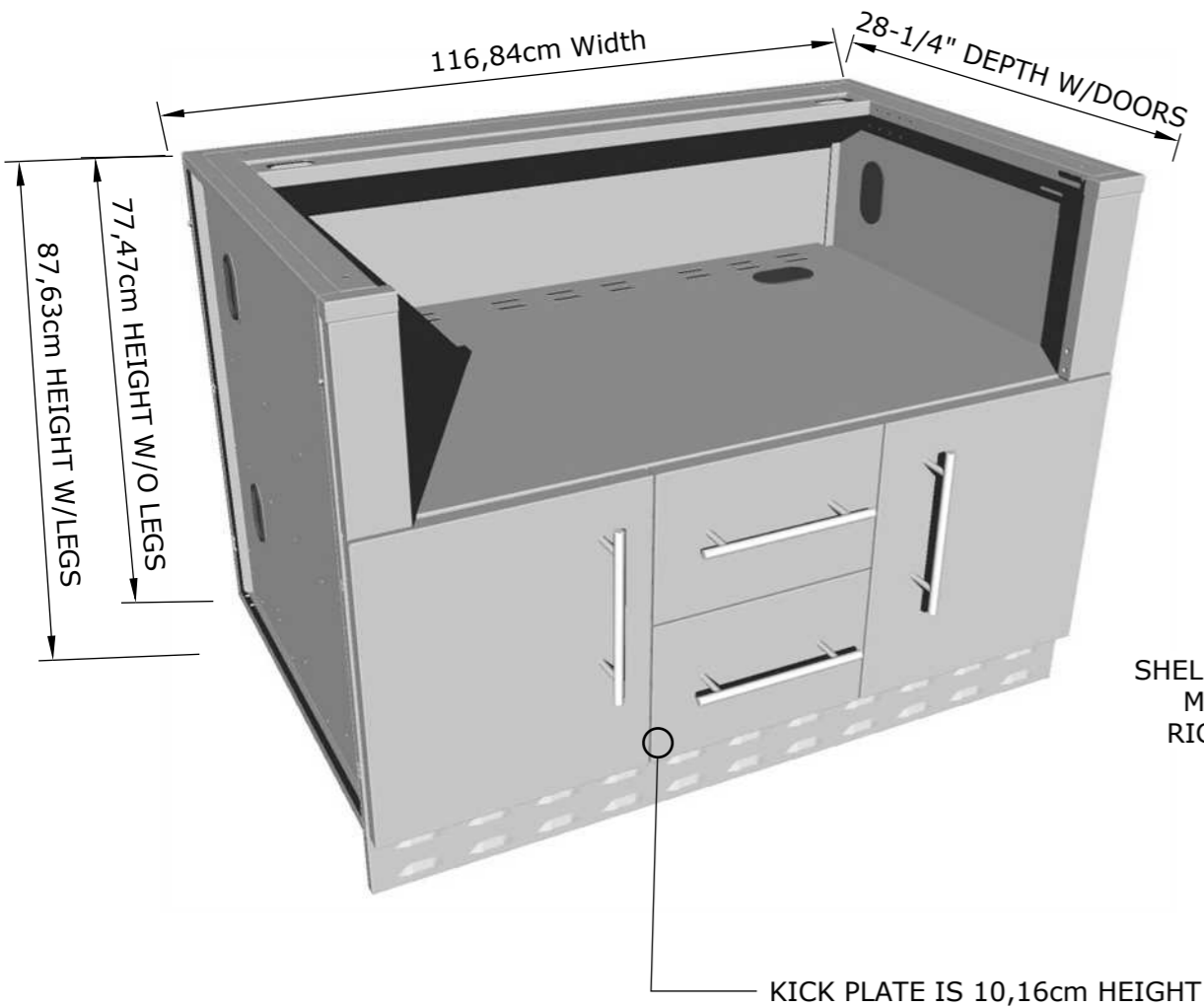

Product Components

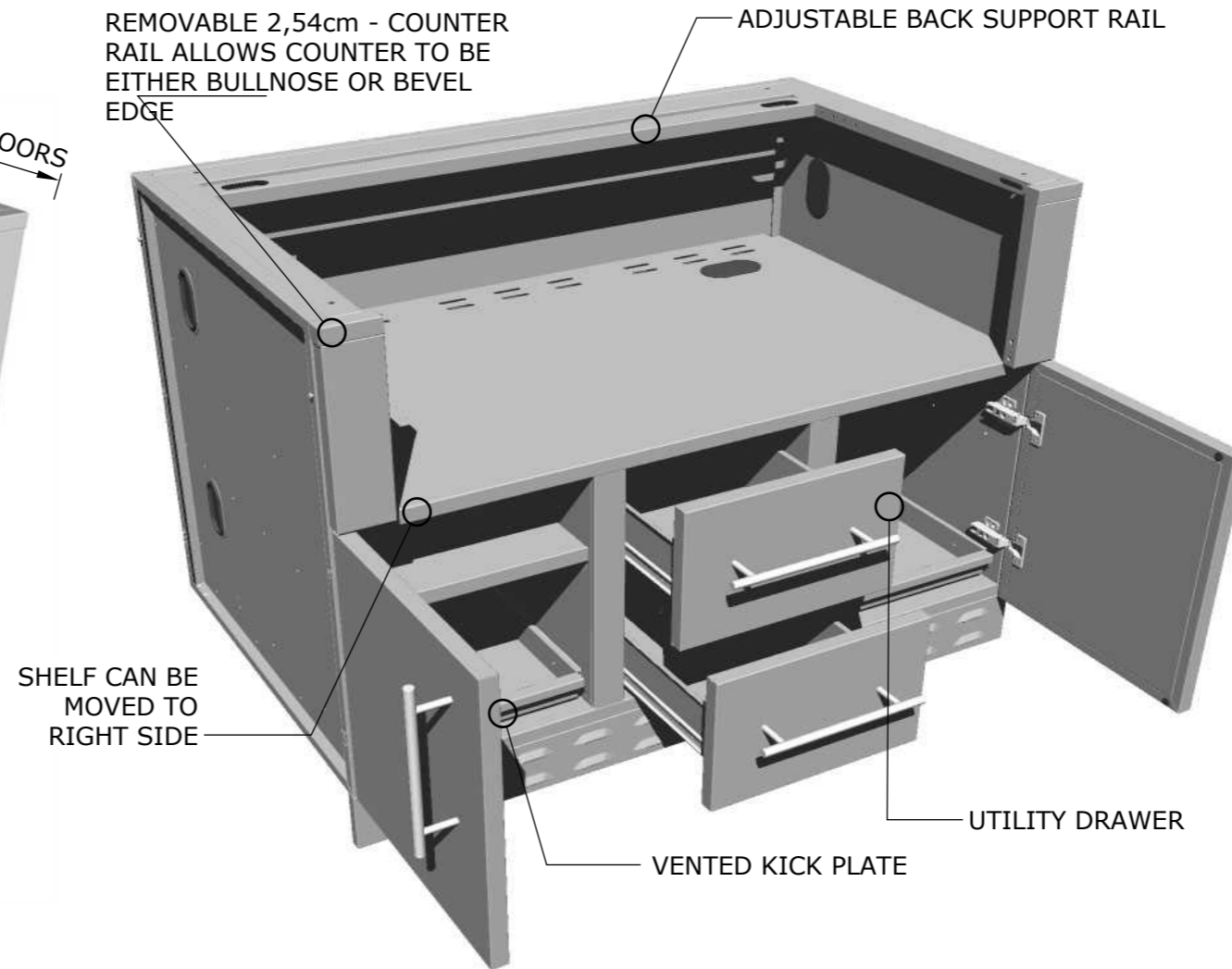

Product Diagrams

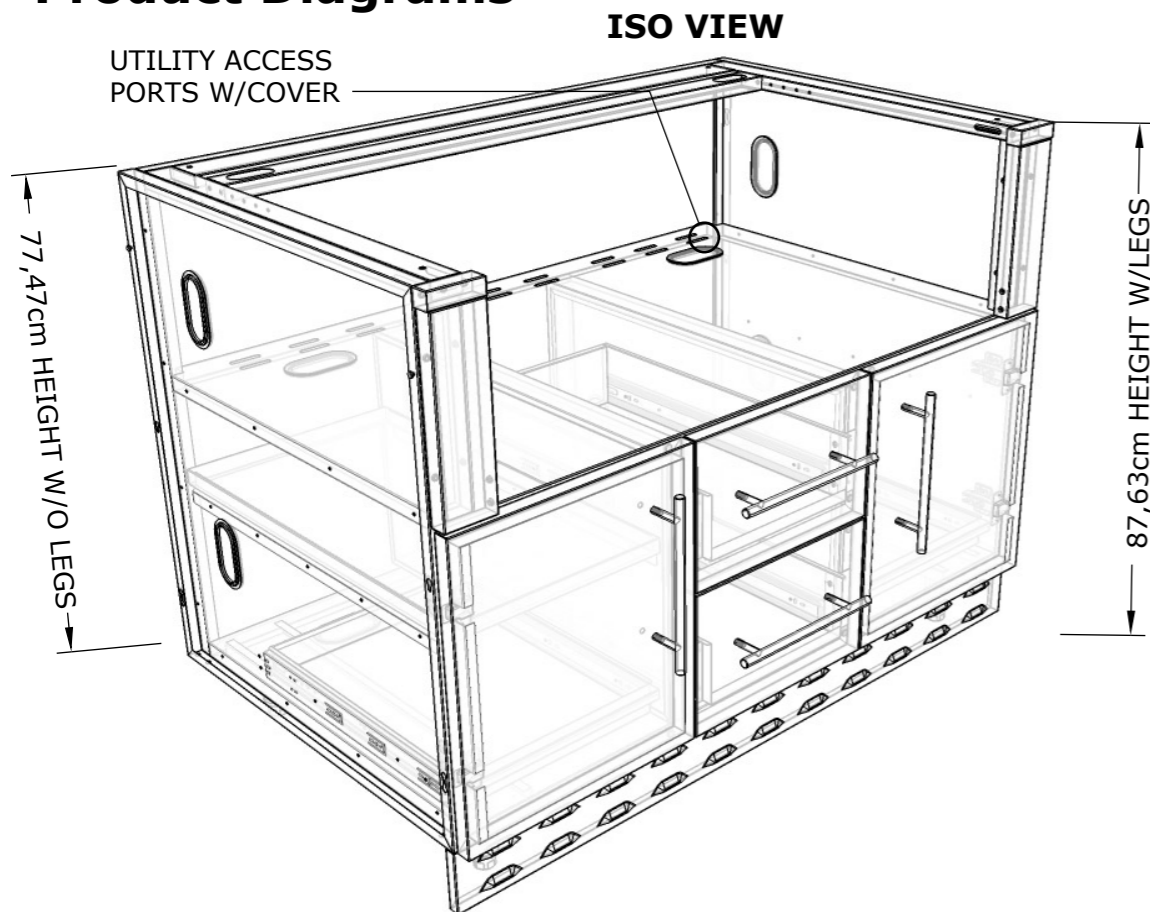

TOP VIEW

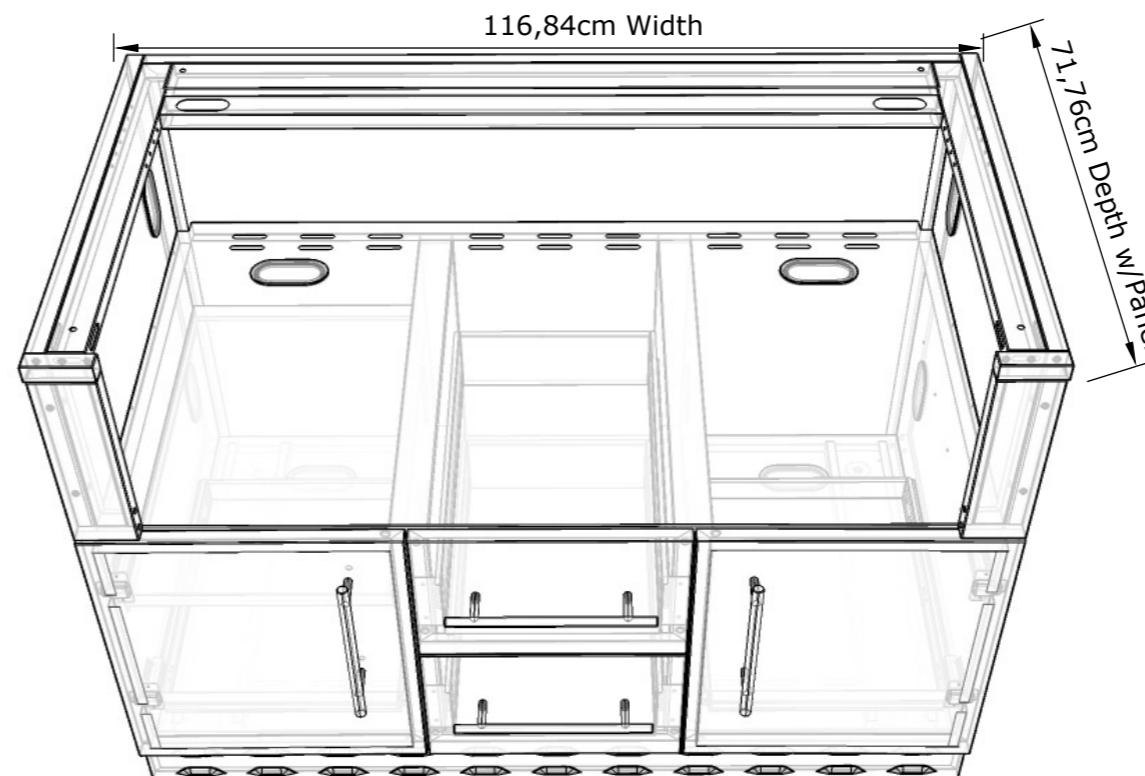

Av. Combatentes do Ultramar, 184
2715-906 Lameiras, Sintra, Portugal
Tel. (+351) 219 670 073
Email: info@sunstoneoutdoorkitchens.com

PRODUCT

Appliance Cabinet for
Item No. SUNCHDZ42

Item No. SAC46CGDC

DESCRIPTION

Appliance Cabinet for Item No.
SUNCHDZ42

- Lifetime Structure Warranty
- 304 Stainless Steel Structure
- 304 SS Rod Handles
- Front & Back Kick-Plates
- Easy Pin-Lock Installation
- Soft-Close Drawer Tracks
- Covered Access Ports
- Adjustable Peg-Legs
- Optional Wheel Casters

INCLUDED COMPONENTS

- Front Vented Kick Plate
- Back Solid Kick Plate
- (4) Adjustable Peg Legs
- Trim-Kit - SCC46CTK3.25

PRODUCT DIMENSIONS

116,84cm W x 71,76cm D (w/Doors)
x 87,63cm H (w/Legs) or 77,47cm H
(no Legs) or Upto 91,44cm Max
Adjustable Height

INSERTABLE PRODUCTS

42" Emerald Hybrid
Item No. EMCHDZ42

(See next page Trim Kit Guide for
other insertable product Brands)

MATERIAL SPECS

304 Stainless Steel entire
structure, 18 Gauge for Door
Panel, 18 Gauge for Cabinet
Box, 18 Gauge for Shelf,
Handles are made of Solid 304
Stainless Steel Bar.

SAC46CGDC TRIM-KIT

Disclaimer: The trademarks used in the "Product Option" column below belong to their respective owners who do not sponsor nor are they affiliated with Sunstone Outdoor Kitchens. The specific product Cut-Out Dimensions have not been directly confirmed by any Sunstone Outdoor Kitchens, representative or employee. Use own discretion to confirm exact product fit.

Model Number	Sleeve Cut-Out	Product Option
SCC46CTK2.5	102,87cm Width x 32,39cm Height x 62,23cm Maximum Depth	Twin Eagles® 42" Grill
SCC46CTK3.25	100,33cm Width x 34,93cm Height x 62,23cm Maximum Depth	Sunstone® Emerald Series 42" Gas Hybrid Charcoal Grill
SCC46CTK3.75	97,16cm Width x 26,35cm Height w/Rail or 32,39cm Height wo/Rail x 62,23cm Maximum Depth	
SCC46CTK4.5	93,66cm Width x 26,35cm Height w/Rail or 32,39cm Height wo/Rail x 62,23cm Maximum Depth	
SCC46CTK5	90,81cm Width x 26,35cm Height w/Rail or 32,39cm Height wo/Rail x 62,23cm Maximum Depth	Twin Eagles® 36" Grill

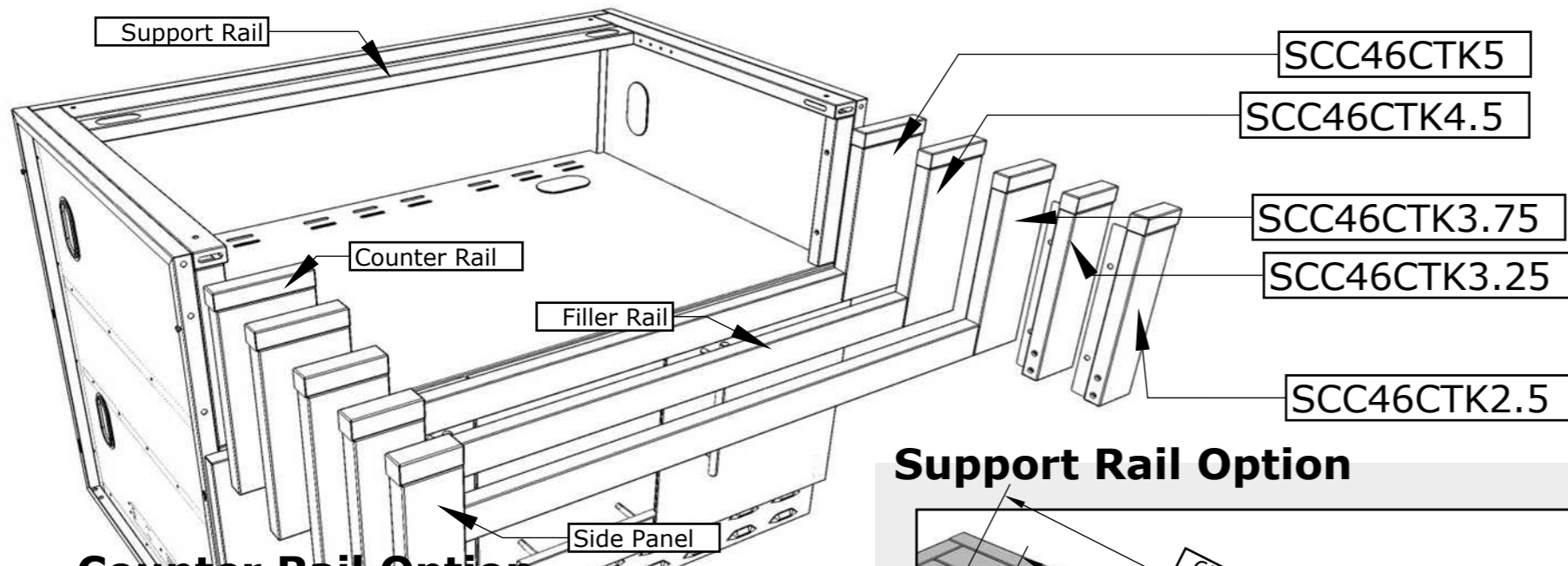

Counter Rail Option

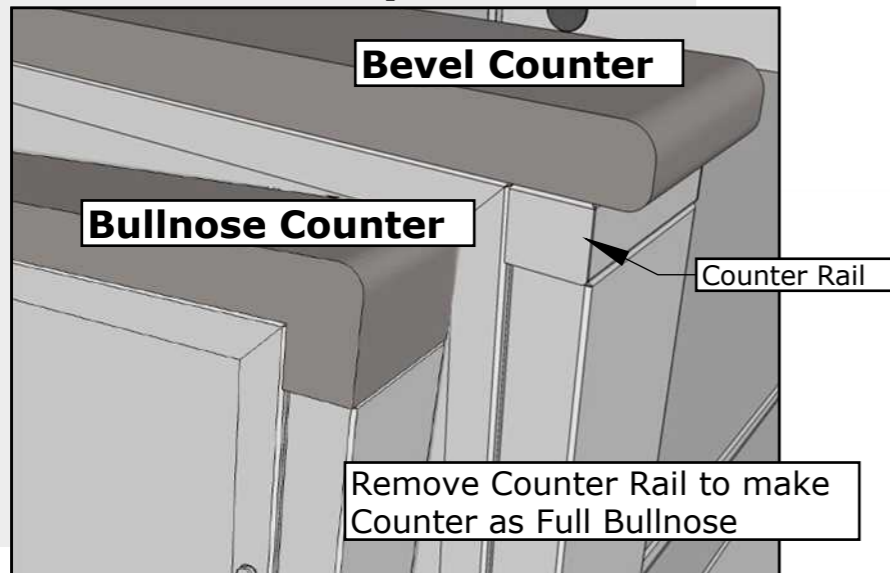

Support Rail Option

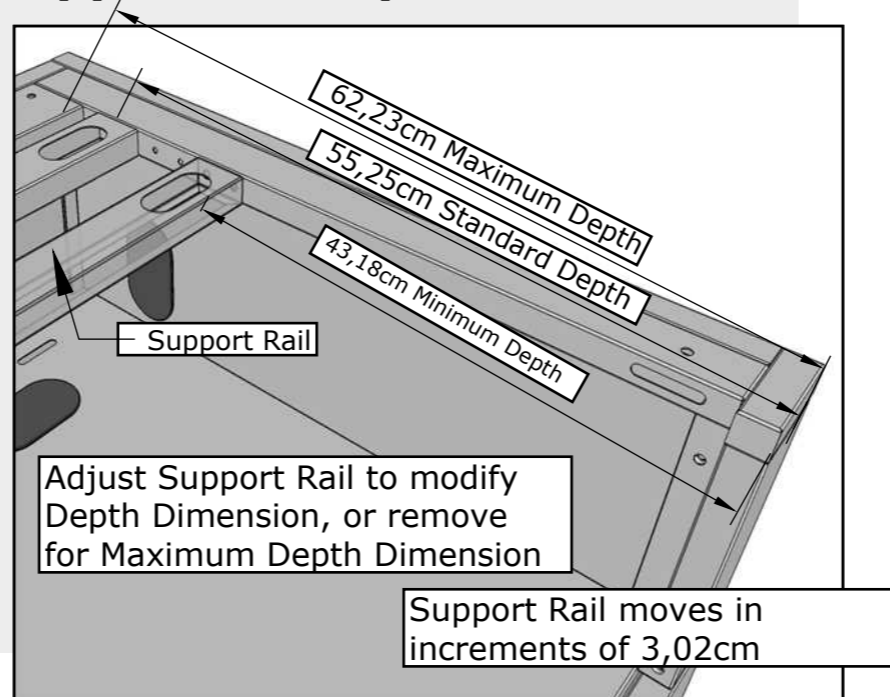

Trim-Kit Sleeve Dimensions

Compatible between 90,81cm to 102,87cm, 26,35cm to 32,39cm Max Height with counter at 1,91cm Height with Filler Rail installed or removed. (Additional Height can be adjusted by Removing Bottom Filler Rail or by adding a Thicker Counter or Backer Board)

Item No. SCC46CTK2.5

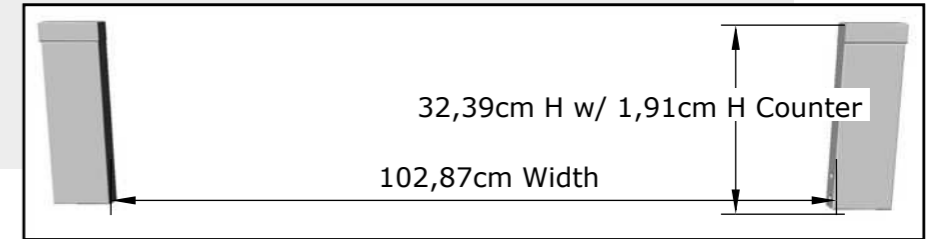

Item No. SCC46CTK3.25

COMES STANDARD

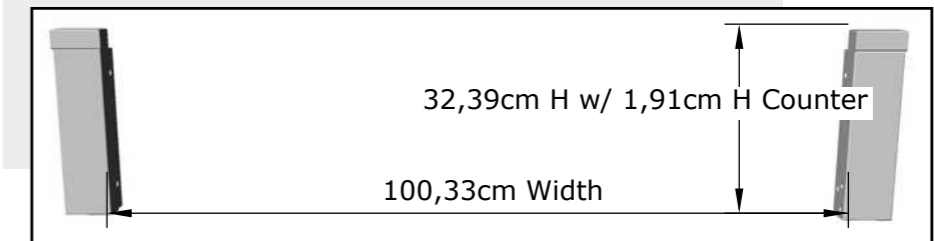

Item No. SCC46CTK3.75

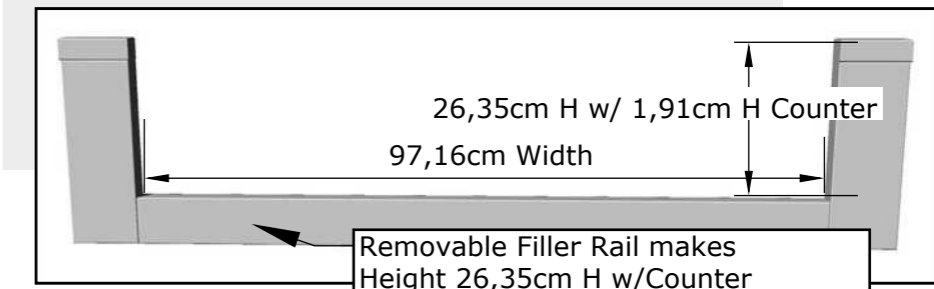

Item No. SCC46CTK4.5

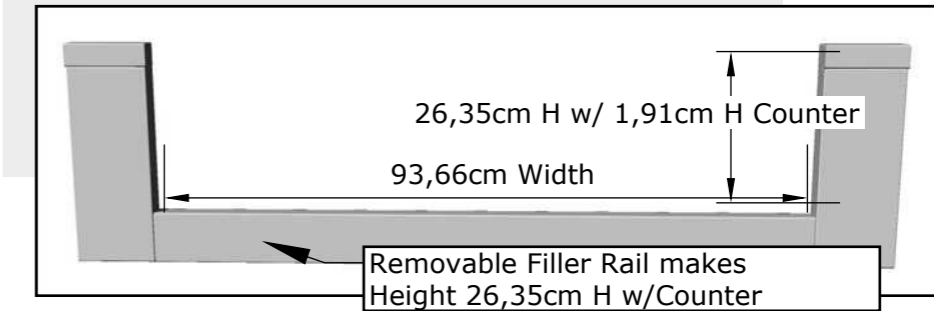

Item No. SCC46CTK5

